

Article number: 021816011130

Description: Clamp with bracket and rubber  
SPGU 6011. 130/30 SK

## Measures

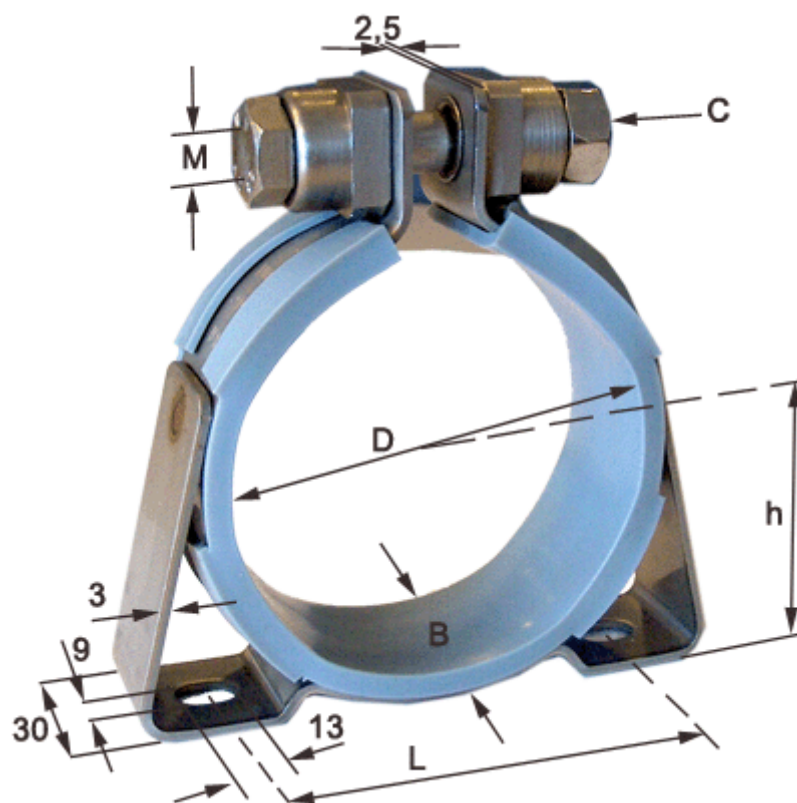

C (screw type) = SK hexagon screw

Diameter D = 130

h = 73

L = 136

Width B = 30